

OPERATING INSTRUCTIONS

PIC152N



SPECIFICATIONS

1. DISPLAY

- 4-digit (7 segment LED) 0.5" height Display Messages:
- "Or" - a) Appears when measurement exceeds display scaling range(9999) for signal inputs
 - b) When open sensor is detected. (Applicable for TC/RTD/-5 to 56mV)
 - "rE" a) Appears when measurement is below display scaling range (-1999) for signal inputs.
 - B) Sensor reverse condition occurs. (Applicable for TC/RTD/mV)

Display alternating between PV and ALrM with LED of respective alarm flashing.(Programmable annunciator option)

LED Status Annunciators - Alarm ON (2 nos)

2. POWER

AC Versions - 85 to 270V AC, 50 or 60 Hz, 5VA
DC Versions (optional) - 24V DC.

3. SETTINGS

Via three keys on front panel.

4. MEMORY

Nonvolatile EEPROM retains all programmable parameters and values.

5. MAIN SENSOR INPUT (Universal)

Thermocouple inputs

- J : -200 to 750°C
- K : -200 to 1350°C
- T : -200 to 400°C
- R : 0 to 1750°C
- S : 0 to 1750°C

RTD input (2 wire or 3 wire)

PT100: -100 to 850°C

Signal inputs

- mV (linear) : - 5 to 56mV
- Voltage: 0 - 10 VDC
- Current: 0 - 20mA DC

6. INDICATION ACCURACY

Temperature:0.25% of Span \pm 1°C (20min.Warmup)

Signal input: 0.05% \pm 1 digit

7. ALARM OUTPUTS

2 nos : Relay output: 5A @ 250 VAC or 24 VDC

Alarm modes - Alarm High, Alarm Low, Band, Fault output and Fault diagnosis.

Hysteresis - Programmable.

Annunciator - Programmable.

Reset Action - Programmable: automatic or latched.

Standby Mode - Programmable: enable or disable.

8. SENSOR SUPPLY

24 VDC supply to power the sensor

9. LINEAR DC OUTPUT (optional)

Re-transmission: 4 to 20 mA or 0 to 5 V or 0 to 10V
Update rate: 100msec.

10. ENVIRONMENTAL CONDITIONS

Operating Range: 0 to 50°C
Storage Range: -20 to 75°C
Humidity: 85% max.

11. ISOLATION BREAKDOWN RATINGS

AC line with respect to all inputs and outputs: 2000 Volts. All other inputs and outputs with respect to relay contacts: 2000 VAC

12. CONNECTION

Wire clamping screw terminals

13. WEIGHT

300 grams

SAFETY SUMMARY

All safety related codifications; symbols and instructions that appear in this operating manual or on the equipment must be strictly followed to ensure the safety of th operating personnel as well as the instrument.

If the equipment is not handled in a manner specified by the manufacturer it might impair the protection provided by the equipment.

CAUTION: Read complete instructions prior to installation and operation of the unit.

CAUTION: Risk of electric shock.

WIRING GUIDELINES

CAUTION:

- To prevent the risk of electric shock power supply to the equipment must be kept OFF while doing the wiring arrangement.
- Wiring shall be done strictly according to the terminal layout with shortest connections. Confirm that all connections are correct.
- Use lugged terminals to meet M3 screws.
- To eliminate electromagnetic interference use of short wire with adequate ratings and twists of the same in equal size shall be made.
- Cable used for connection to power source, must have a cross section of 1mm² or greater. These wires shall have insulation capacity made of at least 1.5KV.

MAINTENANCE

- The equipment should be cleaned regularly to avoid blockage of ventilating parts.
- Clean the equipment with a clean soft cloth. Do not use Isopropyl alcohol or any other cleaning agent.

INSTALLATION GUIDELINES

CAUTION:

- This equipment, being built-in-type, normally becomes a part of main control panel and in such case the terminals do not remain accessible to the end user after installation and internal wiring.
- Conductors must not come in contact with the internal circuitry of the equipment or else it may lead to a safety hazard that may in turn endanger life or cause electrical shock to the operator.
- Circuit breaker or mains switch must be installed between power source and supply terminals to facilitate power 'ON' or 'OFF' function. However this switch or breaker must be installed in a convenient position normally accessible to the operator.

CAUTION:

- The equipment shall not be installed in environmental conditions other than those mentioned in this manual.
- Fuse Protection: The equipment does not have a built-in type fuse. Installation of external fuse of rating 275 VAC/ 1Amp for electrical circuitry is highly recommended.

- Thermal dissipation of equipment is met through ventilation holes provided on chassis of equipment. Such ventilation holes shall not be obstructed else it can lead to a safety hazard.
- The output terminals shall be strictly loaded to the manufacturer specified values/range.

Mechanical Installation:

For installing the controller

- Prepare the panel cutout with proper dimensions as shown

DIMENSIONS (in mm)

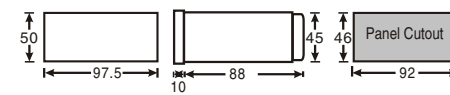

- Remove clamp from the controller and push the controller into the panel cutout. Secure the controller in its place by pushing the clamp on rear side.
- For proper sealing, tighten the screws evenly with required torque.

CAUTION:

The equipment in its installed state must not come in close proximity to any heating sources, caustic vapors, oils, steam, or other unwanted process by-products.

EMC Guidelines:

- Use proper input power cables with shortest connections and twisted type.
- Layout of connecting cables shall be away from any Internal EMI source.

TERMINAL CONNECTIONS

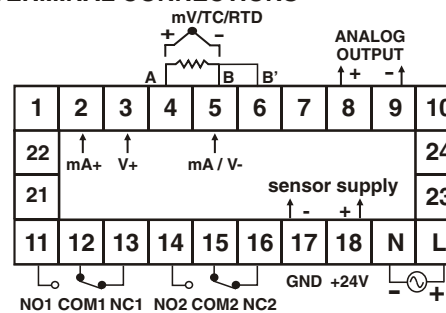

TERMINAL DESCRIPTION	TERMINAL
Live	L
Neutral	N
+ve mA	2
+ve V	3
+ve mV / TC / RTD1	4
-ve mV / TC- / RTD 2 / -ve mA / - ve V	5
+ve analog output	8
-ve analog output	9
NO for relay1	11
COM for relay1	12
NC for relay1	13
NO for relay2	14
COM for relay2	15
NC for relay2	16
GND / -ve sensor supply	17
+24 V / +ve sensor supply	18

KEYS DESCRIPTION

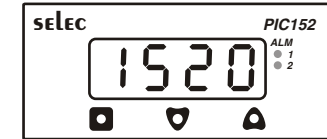

Functions	Key press
To enter or exit program mode	Δ + ∇ together for 3 seconds
To change levels	Δ or ∇ till Level is displayed. \square + Δ / ∇ to increase or decrease the level number.
To view function on the same level and to display the current option.	Δ or ∇ key once to view next/previous function.
To increase or decrease the value of a particular function.	\square + Δ to increase and \square + ∇ to decrease the value of particular function.

NOTE: The unit will autoexit program mode after 60 seconds of inactivity.

To enter or exit program mode:
Press Δ & ∇ together for 3 seconds

KEY PRESS	DISPLAY	DESCRIPTION
Press Δ + ∇ for 3sec	ld 0	Lock code Enter valid lock code as set in the [LOC] parameter of level 0.

NOTE: Lock code will not be prompted if jumper J1 (besides the calibration jumper) is present.

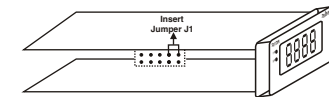

PROGRAMMING OF LEVELS

PROGRAMMING OF LEVEL 0

KEY PRESS	DISPLAY	DESCRIPTION
Press Δ key	LULI	
Press \square + ∇ Key	LUL0	Parameters in this level can be set.

Press Δ key to select input sensor type

Key Press	Display	Description
	inp	Default setting: J Input sensor selection
	J	J (-200 to 750°C)
Press \square + Δ	K	K (-200 to 1350°C)
Press \square + Δ	T	T (-200 to 400°C)
Press \square + Δ	R	R (0 to 1750°C)
Press \square + Δ	S	S (0 to 1750°C)
Press \square + Δ	P100	PT100 (-100 to 850°C)
Press \square + Δ	mV	mV (linear) -5 to 56mV
Press \square + Δ	10VDC	10 VDC
Press \square + Δ	20mA DC	20mA DC

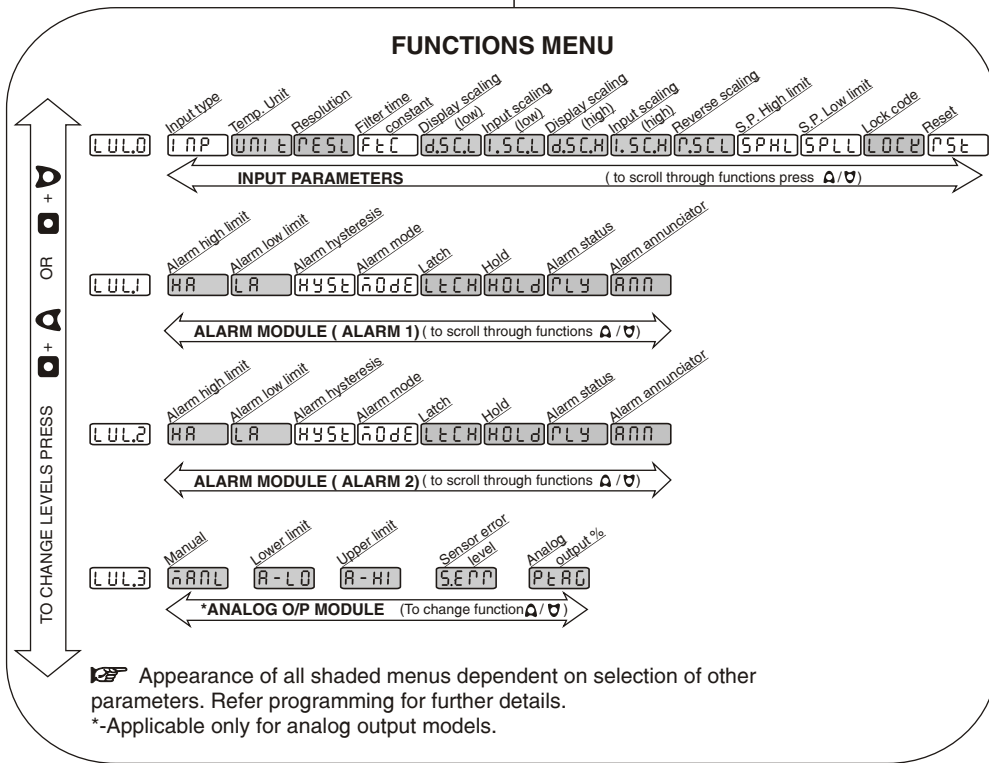

KEY PRESS	DISPLAY	DESCRIPTION
Press [] key to select Temperature unit Default setting: °C NOTE: This parameter is not prompted if analog input is selected.		
Temperature Unit		
	Display [] for 1sec	
	[]	Value displayed in °C
Press [] + []	[]	Value displayed in °F
Press [] key to select Resolution Default value: 1 NOTE: This parameter is not prompted if input is R, S type thermocouple.		
Resolution		
	Display [] for 1sec	
	[]	Range: 1 / 0.1 for TC / RTD
Press [] + []	[]	1 / 0.1 / 0.01 / 0.001 for AIN
Press [] key to select Filter time constant Default value: 1sec		
Filter time constant *		
	Display [] for 1sec	
Press [] + []	[]	Range: OFF, 1 to 99 sec

Press [] key to select Display value scaling point1 Default value: 0 NOTE: This parameter is not prompted if TC/RTD input types are selected		
Display value scaling point low (DSCL) *		
	Display [] for 1sec	
Press [] + [] / []	[]	Range : -1999 to DSCH For AIN display as per decimal point selected.
Press [] key to select input value scaling point 1 Default value: 0.00 NOTE: This parameter is not prompted if TC/RTD input types are selected		
Input value scaling point low (ISCL) *		
	Display [] for 1sec	
Press [] + [] / []	[]	Range : 0.0mA / -5mV / 0.0 V to ISCH (default value changes as per analog input selected)
Press [] key to select Display value scaling point 2 Default value: 9999 NOTE: This parameter is not prompted if TC/RTD input types are selected		
Display value scaling point high (DSCH) *		
	Display [] for 1sec	
Press [] + [] / []	[]	Range : DSCL to 9999 For AIN display as per decimal point selected.

Note: * mark explained in the user guide.
AIN - Analog Input

KEY PRESS	DISPLAY	DESCRIPTION
Press [] key to select Input value scaling point 2 Default value: 20.0mA NOTE: This parameter is not prompted if TC/RTD input types are selected		
Input value scaling point high (ISCH) *		
	Display [] for 1sec	
Press [] + [] / []	[]	Range: ISCL to 20.00mA / 56mV / 10.00V (default value changes as per analog input selected)
Press [] key to select Reverse scaling Default setting: [] NOTE: This parameter is not prompted if TC/RTD input types are selected		
Reverse scaling*		
	Display [] for 1sec	
Press [] + []	[]	The display scaling point settings can be reversed by selecting Reverse scaling as []
Press [] key to select Set point high limit (SPHL) Default value: 750°C		
	Display [] for 1sec	
Press [] + [] / []	[]	Range :SPLL to max. range of sensor (for TC/RTD)SPLL to DSPH (for AIN) For AIN display as per decimal point selected.
Press [] key to select Set point low limit Default value: -200°C		
Set point low limit (SPLL)		
	Display [] for 1sec	
Press [] + [] / []	[]	Range : min. range of sensor to SPHL (for TC/RTD) DSCL to SPHL (for AIN) For AIN display as per decimal point selected.
Press [] key to select Lock code Default setting: 0		
Lock code		
	Display [] for 1sec	
Press [] + [] / []	[]	Range :0 to 9999

Press [] key to select Reset Default setting: [] Reset		
	Display [] for 1sec	
Press [] + []	[]	All parameters set to factory setting
NOTE: After altering the value of the input parameters press [] or [] for change to actually take effect.		
NOTE: Programming steps for Level1 (Alarm1 module) & Level2 (Alarm2 module) is same. Programming of level1 is shown.		
PROGRAMMING OF LEVEL 1		
Press [] + [] till Level 1 is displayed		
KEY PRESS	DISPLAY	DESCRIPTION
	[]	Parameters in this level can be set.
Press [] key to select Alarm high limit Default value: 750°C NOTE: This parameter is not prompted if alarm mode is [] [] [] []		
Alarm high limit		
	Display [] for 1sec	
Press [] + [] / []	[]	Range: LA to SPHL (BAND mode) SPLL to SPHL (HA mode) For AIN display as per decimal point selected.
Press [] key to select Alarm low limit Default value: -200°C NOTE: This parameter is not prompted if alarm mode is [] [] [] []		
Alarm low limit		
	Display [] for 1sec	
Press [] + [] / []	[]	Range: SPHL to HA (BAND mode) SPLL to SPHL (LA mode) For AIN display as per decimal point selected.
Press [] key to select Alarm hysteresis. Default value: 1.0 NOTE: This parameter is not prompted if alarm mode is [] [] [] []		
Alarm hysteresis		
	Display [] for 1sec	
Press [] + [] / []	[]	Range: 0.1 to 99.9 °C (for TC/RTD) 1 to 999 (for analog input) For AIN display as per decimal point selected.

KEY PRESS	DISPLAY	DESCRIPTION
Press Δ key to select Alarm mode. Default setting: \square HR In level 2 default setting is \square LR		
Alarm mode *		
Display \square ODE for 1sec		
	\square OFF	Alarm off
Press \square + Δ	\square HR	High Alarm
Press \square + Δ	\square LR	Low Alarm
Press \square + Δ	\square BRd	Band Alarm
Press \square + Δ	\square FdA	Fault Diagnosis Alarm
Press \square + Δ	\square FOA	Fail Output Alarm
Press Δ key to select Alarm latch status. Default setting: \square OFF		
NOTE: This parameter is not prompted when alarm mode is \square OFF		
Latch alarm*		
Display \square LECH for 1sec		
Press \square + Δ	\square OFF	When latch is ON Alarm status will be preserved at any process condition.
	\square ON	
Press Δ key to select Alarm hold status. Default setting: \square OFF		
NOTE: This parameter is not prompted if alarm mode is \square OFF		
Hold Alarm*		
Display \square HOLD for 1sec		
Press \square + Δ	\square OFF	Used to avoid alarm at power ON. Alarm is enabled only after the process value has reached the set point.
	\square ON	
Press Δ key to select Relay status for alarm1. Default setting: \square EN		
NOTE: This parameter is not prompted when alarm mode is \square OFF		
Relay status for Alarm1		
Display \square PLY for 1sec		
	\square EN	Relay Energized.
Press \square + Δ	\square dEN	Relay De - energized
Press Δ key to select Alarm annunciator. Default setting: \square OFF		
NOTE: This parameter is not prompted if alarm mode is \square OFF		
Alarm annunciator*		
Display \square RdN for 1sec		
	\square OFF	No annunciator
Press \square + Δ	\square LEd	
	\square LED	LED of alarm1 blinks at the rate of 0.2sec
Press \square + Δ	\square dSP	LED blinking; display flashing b/w PV and message (ALRM) at 1sec

NOTE: Applicable only if Analog output is available.

PROGRAMMING OF LEVEL 3

Press \square + Δ till Level 3 is displayed

KEY PRESS	DISPLAY	DESCRIPTION
	\square LUL3	Parameters in this level can be set.
Press Δ key to select Manual. Default setting: \square OFF		
Manual		
Display \square MANL for 1sec		
	\square OFF	Used to set manual output On / Off.
Press \square + Δ	\square ON	
Press Δ key to select Analog low scaling point Default value: -9999		
NOTE: This parameter is prompted only if manual is \square OFF		
Low scaling point		
Display \square A-L0 for 1sec		
Press \square + Δ / ∇	\square 9999	Programmable from -1999 to 9999. Fixed 1°C resolution for TC / RTD. For AIN display as per decimal point selected.
to change value		
Press Δ key to select Analog high scaling point Default value: 9999		
NOTE: This parameter is prompted only if manual is \square OFF		
High scaling point		
Display \square A-H1 for 1sec		
Press \square + Δ / ∇	\square 9999	Programmable from -1999 to 9999. Fixed 1°C resolution for TC / RTD. For AIN display as per decimal point selected.
to change value		
Press Δ key to select Sensor error level Default setting: \square HIGH		
Sensor error level		
Display \square SEPP for 1sec		
Press \square + Δ	\square HIGH	In case of sensor failure the output can be set to high or low value of range.
	\square LOW	
Press Δ key to select Analog output %. Default setting: \square 00		
NOTE: This parameter is prompted only if manual is \square ON		
Analog output %		
Display \square PER0 for 1sec		
Press \square + Δ / ∇	\square 00	Programmable from 0.0 to 100.0
to change value		

USER GUIDE :

ALARM MODES

High Alarm:

The alarm is turned ON when PV rises above a preset value.

Low Alarm:

The alarm is turned ON when PV falls below a preset value.

Band Alarm:

The alarm is turned ON when PV rises above or falls below a preset value.

Fault Diagnosis Alarm:

The alarm is turned ON in case a hardware failure occurs.

Fail Output Alarm:

The alarm is turned ON in case of :

- measurement value exceeds range
- Sensor reverse condition (applicable for TC/RTD).

Latch Alarm:

This function is used to latch the alarm. When activated, the alarm is latched until it is acknowledged manually, even though the alarm condition may have disappeared.

Hold Alarm:

When hold is selected, in any alarm mode, it prevents an alarm signal on power-up. The alarm is enabled only if the process temperature is within alarm range.

Alarm display options:

- Press the \square key to view the status of alarms
- Press \square + ∇ to view the status of next alarm (after alarm 2 it rolls over to alarm 1).

Only the alarms that are active can be viewed.

Alarm status (e.g : of alarm 1) will be displayed as follows:

LA-1 for low alarm, HA-1 for high alarm, FO-1 for Fail output

Alarm display options:

- Press the \square key to view the status of alarms
- Press \square + ∇ to view the status of next alarm (after alarm 2 it rolls over to alarm 1).

Only the alarms that are active can be viewed.

Alarm status (e.g : of alarm 1) will be displayed as follows:

LA-1 for low alarm, HA-1 for high alarm, FO-1 for Fail output alarm, FD-1 for fault diagnosis.

- Press \square + Δ to acknowledge the particular alarm (Alarm will be acknowledged only if latch ON).

FILTER TIME CONSTANT:

The filter is an adaptive digital filter that discriminates between measurement noise and actual process changes. If the signal is varying too greatly due to measurement noise, increase the filter value. If the fastest controller response is needed, decrease the filter value.

SCALING FOR ANALOG INPUT:

To scale the controller, two scaling points are necessary. Each scaling point has a coordinate pair of Display Values and Input Values. It is recommended that the two scaling points be at the low and high ends of the input signal being measured. Process value scaling will be linear between and continue past the entered points to the limits of the input range. (Factory settings example will display 0.0 at 0mA input and display 9999 at 20.00mA input.) Reverse acting indication can be

accomplished by setting reverse scaling parameter as YES. In this case referring the above eg. For 0.00mA input the display will show 9999 and 20.00mA input the display will show 0.0. NOTE: This change will not be visible in the programming menu.

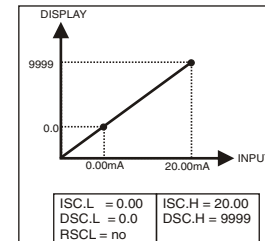

SETTING FOR MANUAL OUTPUT MODE :-

KEY PRESS	DISPLAY	DESCRIPTION
Eg. For 4-20 mA if constant 12mA output current is desired then setting for manual output :		
Press \square + Δ	\square LUL3	
Press Δ key	\square MANL	display momentarily
Press \square + Δ / ∇	\square ON	(Selection for manual output mode)
Press Δ	\square PER0	
Press \square + Δ / ∇	\square 500	Adjust the display to 50.0 to get 12mA at output

SETTING FOR RETRANSMISSION MODE

Eg. :1) For Temperature Input :-

Input : RTD Input
Retransmission output : 4 - 20 mA
Desired output : 4mA at 0°C, 20mA at 400°C
Settings :

Press Δ + ∇	\square LUL1	
Press \square + ∇	\square LUL0	
Press Δ key	\square INP	
Using \square + Δ / ∇	\square P100	Select the Input type as RTD
Press Δ till	\square LUL0	is displayed
Press \square + Δ till	\square LUL3	is displayed
Press Δ key	\square MANL	display momentarily
and then display	\square OFF	(Selection for retransmission mode)
Press Δ	\square A-L0	
Press \square + Δ / ∇	\square 0	Adjust the display to 0
Press Δ	\square A-H1	

KEY PRESS	DISPLAY	DESCRIPTION
Press \square + Δ / ∇	400	Adjust the display to 400
Press Δ key		
Eg. : 2) For analog Input :-		
Retransmission output : 4 - 20 mA		
Desired output : 4mA at 0V ; 20mA at 10V		
Input Scaling : 0V - 0; 10V - 400		
Settings :		
Press Δ + ∇	LUL.I	
Press \square + ∇	LUL.0	
Press Δ	INP	
Using \square + Δ / ∇	UOLt	Select the Input type as voltage
Press Δ until	d.S.C.L	is displayed
Using \square + Δ / ∇	0	Adjust the display to 0
Press Δ	1.S.C.L	
Press \square + Δ / ∇	0.00	Adjust the display to 0
Press Δ	d.S.C.H	
Press \square + Δ / ∇	400	Adjust the display to 400
Press Δ	1.S.C.H	
Press \square + Δ / ∇	10.0	Adjust the display to 10
Note : By default the display will be 10.00 for 0-10V Input		
Press Δ Key		
Setting for Retransmission :		
Press \square + Δ till	LUL.3	
Press Δ key	RRRL	displays momentarily
and then display	OFF	
	R-L0	
Press \square + Δ / ∇	0	Adjust the display to 0
	R-H1	
Press \square + Δ / ∇	400	Adjust the display to 400
Press Δ key		

CONNECTION WITH 2-WIRE TRANSMITTER

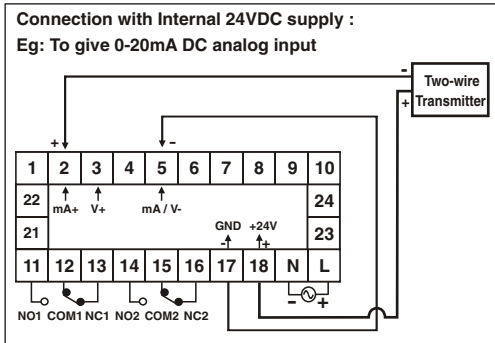

CALIBRATION CERTIFICATE

Date: _____
 Model No: _____
 Sr. No.: _____

Claimed Accuracy: $\pm 0.25\%$ of full scale ± 1 digit (After 20min warmup time)

Sources calibrated against:
 Hinditron Multimeter, Model 86, Sr.No.:1094
Multimeter calibration report no:
 ERTL (W), Mumbai, INDIA

The calibration of this unit has been verified at the following values:

SENSOR	CALIBRATION TEMP.(°C) (0.1Resolution)	DISPLAY VALUE (°c)
K	35.0	35.0
	700.0	700.0
	1350	1350
PT100	0.0	0.0
	500.0	500.0
	800.0	800.0

SENSOR	CALIBRATION VALUE (0.1Resolution)	DISPLAY VALUE
Voltage (VDC)	0.0	0.0
	10.0	10.0
Current (mA)	0.0	0.0
	20.0	20.0

The thermocouple / RTD curves are linearised in this microprocessor based product; and hence the values interpolated between the readings shown above are also equally accurate; at every point in the curve.

Unit is accepted as accuracy is within the specified limit of claimed accuracy and certificate is valid up to one year from the date of issue

CHECKED BY:

(Specifications subject to change as development is a continuous process).

Selec Controls Pvt. Ltd., India,
 (Formerly Selection Process Controls Pvt. Ltd.)
 Tel:91-22-28476443/1882, Fax:91-22-28471733,
 Toll free: 1800 227 353, Website: www.selec.com
 E- mail: sales@selec.com.